



DSA PORT COLLECTION

Impact-Rated Mahogany Doors

The background of the entire page is a marbled paper pattern with swirling, organic shapes in shades of blue, teal, and cream. A white rectangular box is centered on the page, containing the text.

Welcome Home

Nothing feels more like home than the warm welcome of a wood door. For generations, homeowners have invested in wood doors because of their capability and dependability.

Also for generations, the team at DSA Doors has produced superior wood doors. Because secure entry doors are a must for coastal homes, we've tested and engineered our Port Collection to bring DSA's signature quality and protection to your coastal home.



Contents

Impact Protection	1
Technical Details	3
Configurations	7
How to Order	9
Personalization	11
Biscayne Series	15
Clearwater Series	21
Lucie Series	27
Naples Series	34
Venice Series	32

PROTECT YOUR COASTAL HOME WITH DSA IMPACT DOORS

DSA offers two tiers of Impact-Rated doors in our Port Collection - WBD Impact (Florida Certified for the Wind Borne Debris Region) and HVHZ Impact (Florida & Miami/Dade Certified for the High Velocity Hurricane Zone). Engineered to withstand extreme weather conditions, DSA's Port Collection delivers superior safety, security, and style to coastal homes.

To select the appropriate rating for your DSA Impact unit, please consult your local building code requirements specific to your structure and location.

ASCE 7-05 Hurricane Prone Region

ASCE 7-10 Hurricane Prone Region

Wind-Borne Debris Region *(FL Certified Inswing & Outswing single and double doors with sidelite & transom options)*

- Design Pressure +/- 50 psf (ASTM E330-02)
- Certified for Air Infiltration (ASTM E283-04)
- Wind Borne Debris Impact Resistant (ASTM E1996-09)
- Impact certified outside the HVHZ with Cyclic Pressure Differentials (ASTM E1886-05)

High Velocity Hurricane Zone *(FL and Miami-Dade Certified Inswing & Outswing single and double doors)*

- Design Pressure +/- 70 psf (ASTM E330-02) (TAS 202-04)
- Certified for Air Infiltration (ASTM E283-04)
- Certified for Water Infiltration (ASTM E330-00)
- Wind Borne Debris Impact Resistant (ASTM E1996-09) (TAS 201-04)
- Impact certified for HVHZ with Cyclic Pressure Differentials (ASTM E1886-05) (TAS 203-04)
- Excludes full-view doors with arched glass



Visit www.DSADoors.com/Florida to learn more & view codes

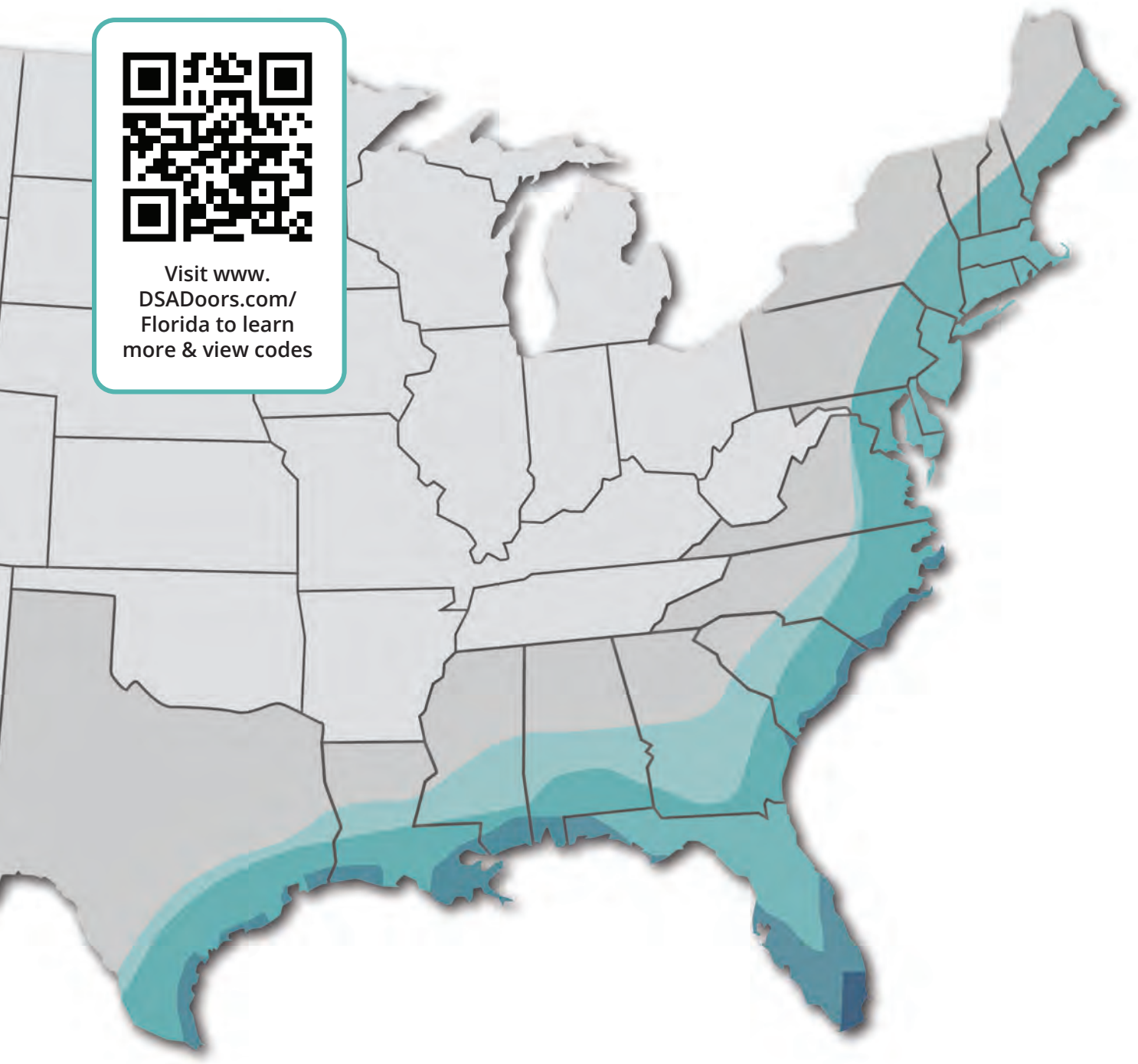

CLEAR LAMINATED IMPACT GLASS

Our Port Collection features high-quality Clear Laminated Impact Glass to ensure maximum protection. For added design flexibility, Port Doors are constructed with Mahogany SDL (Simulated Divided Lite) grids applied to the exterior surface of Impact Glass.

Our 1" thick insulated safety glass will remain secure in the frame and continue to protect against damage, even if damaged, due to its SentryGlas® ionoplast interlayer.

Classic Grids - 7/8" SDL Grids with Ovolo Profile



Wide Grids - 4 1/2" SDL Grids with Ovolo Profile



Laminated Glass

- — Low E Coating
- Argon Gas
- ⓐ 1/8" Annealed
- ⓓ .090" SGP Clear
- ⓔ 1/8" Annealed

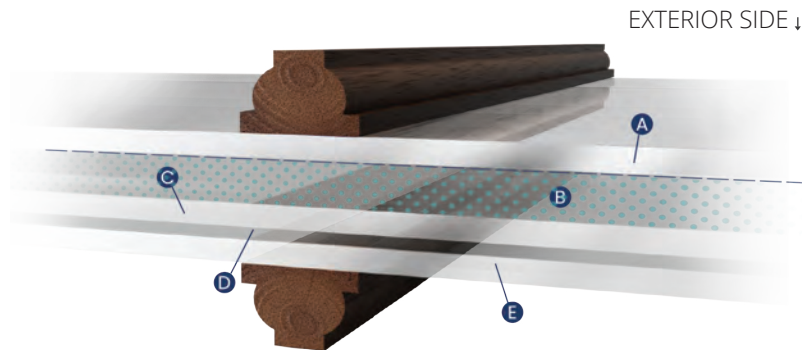

PREMIUM HURRICANE PROTECTION

Our Port doors are 2 ¼" thick, made exclusively with premium Meranti Mahogany, and feature 11-ply panel construction for maximum durability. For additional stability, the top and bottom rail of each door is reinforced with steel bars.

In addition to our protective construction features, our Port Collection doors are equipped with an Ashland® Multipoint Locking System to provide increased performance in everyday life and extreme weather conditions.

Ashland® Multipoint Locking System details:

- Faceplate extends the full length of the door with 1" top and bottom shoot bolts for security and structural integrity.
- To engage the shoot bolts and secure the door in the frame, handle must be pulled up 35°.
- Active & Passive lock required for HVHZ & WBD Impact double doors.

SHOOT BOLT & METAL BARS



Pictured: Biscayne 3LT E-01

PORT TECHNICAL DETAILS

Single & Double Doors

EXTERIOR

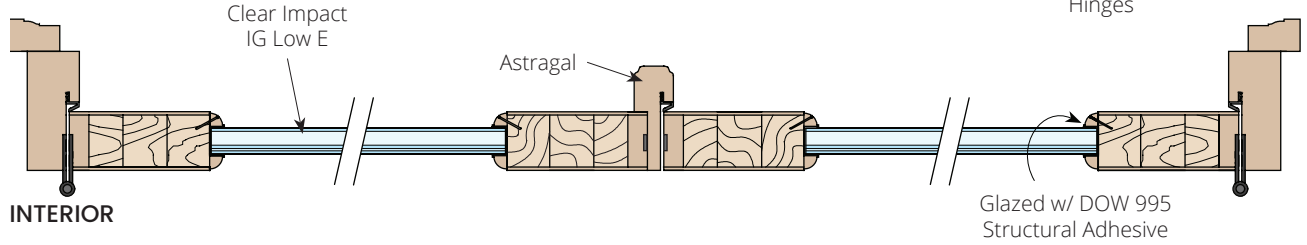
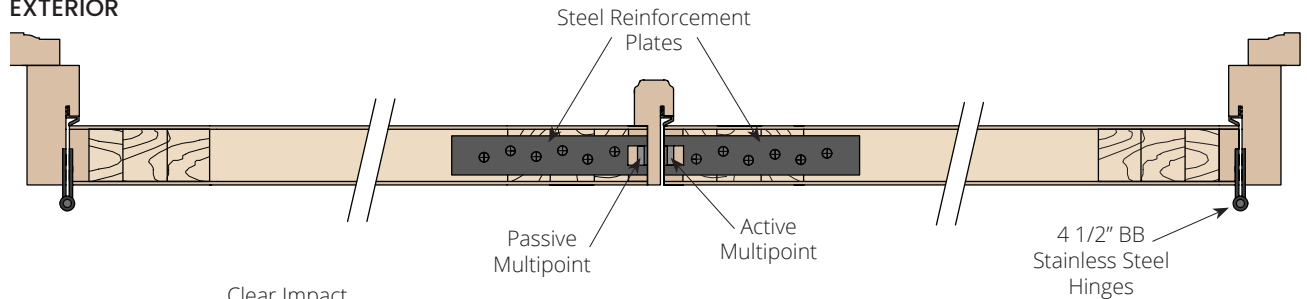

INTERIOR

EXTERIOR

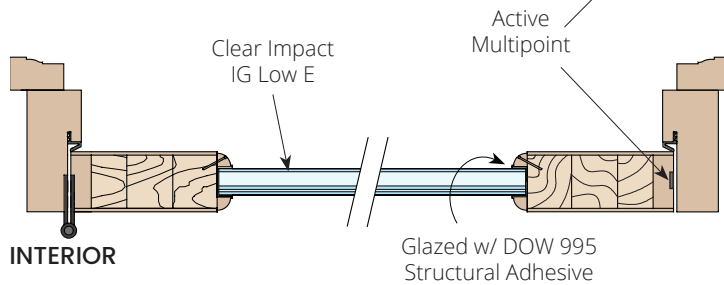
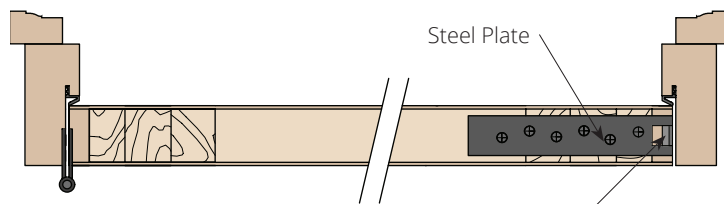

INTERIOR

SOLID MAHOGANY JAMBS

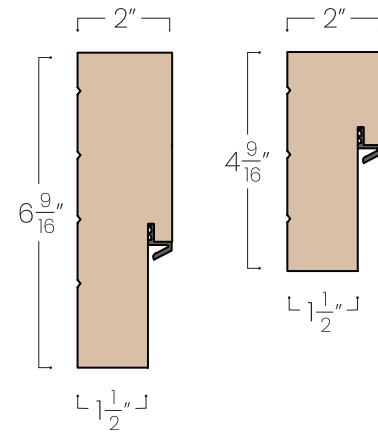

Inswing & Outswing Sills

Schlegel® Hydrosill™ Series 2200

*For Inswing doors
Available in Dark Bronze finish*

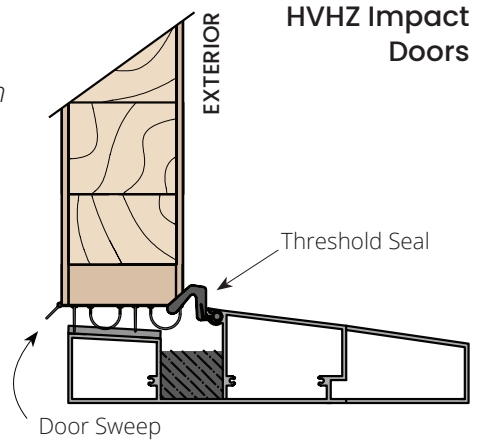
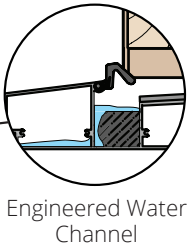
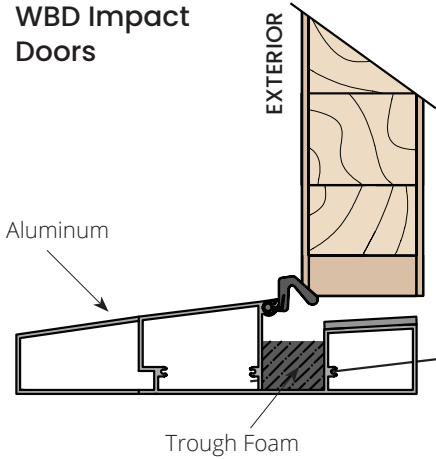

Endura® Bump Sill Z-Series

For Outswing doors in Dark Bronze or Nickel finish with Walnut cap

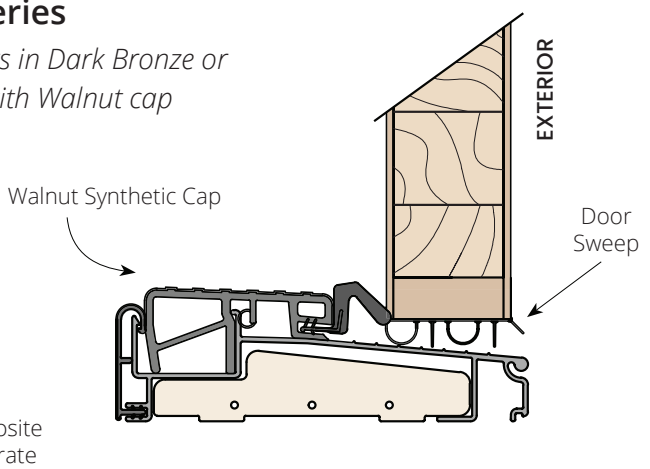
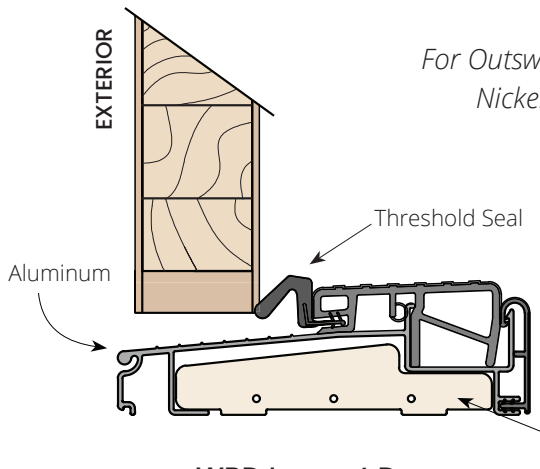

PORT CONFIGURATIONS

HVHZ units are available in single and double door configurations, while WBD Impact includes sidelite and transom options.



E-01

- HVHZ Impact Rated
- WBD Impact Rated



E-01B

- HVHZ Impact Rated
- WBD Impact Rated



E-01 + SL

- WBD Impact Rated



E-04

- HVHZ Impact Rated
- WBD Impact Rated



E-17

- HVHZ Impact Rated
- WBD Impact Rated

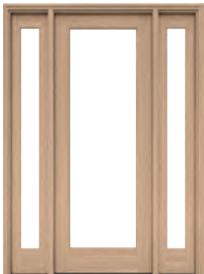

E-03

- WBD Impact Rated



E-04 + T

- WBD Impact Rated



E-09

- WBD Impact Rated

PORT DOOR STYLES

Our Port Collection contains over 100 door styles to flatter a wide variety of traditional and modern coastal homes. Enjoy high-caliber protection against hurricanes without sacrificing aesthetics.



Biscayne Series

E-01, E-01+SL, E-03,
E-04, E-04+T, and
E-09 configurations
6'8" & 8'0" heights



Naples Series

E-01, E-01+SL, E-03,
E-04, E-04+T, and
E-09 configurations
6'8" & 8'0" heights



Clearwater Series

E-01, E-01B, E-04,
E-04+T, and
E-17 configurations
8'0" height
Not available HVHZ
Rated



Lucie Series

E-01, E-01B, E-04,
E-04+T, and E-17
configurations
8'0" height



Venice Series

E-01, E-01B, E-04, &
E-17 configurations
8'0" height



HOW TO ORDER YOUR PORT DOOR

Find your Impact requirement

Reference any required exterior door impact ratings by checking applicable building codes or contacting your local building department.

Measure your entry

Our Port Collection includes 6'8" and 8'0" tall doors in eight configurations. For other entry sizes, our Port styles can be ordered through our Custom department.

Choose your door style

Browse our Port Collection to find the perfect door to complement your home.

Personalize your door

Select your hardware and customization options, as well as any premium custom upgrades.

Find your DSA dealer

We work exclusively with a network of dealers to ensure professional results. Find your DSA dealer at www.DSADoors.com/Dealer



PORT PERSONALIZATION OPTIONS

We believe that Impact doors should be as beautiful and adaptable as they are strong and protective. With our Port Collection doors, you can choose from a wide range of aesthetic options to compliment your traditional or modern home.

Standard Options

- Brickmould and Casing selections
- Artisan Pre-finishing
- Handlesets

Premium Custom Options

- Premium Impact Glass styles
- Muntin Bars in glass
- Personalized styles

Brickmould & Casing Options

Each Port Collection unit is offered with standard 180 or S4S brickmould. You can select a different brickmould style, or add interior casing, for an additional charge. Contact your DSA Dealer for more information.

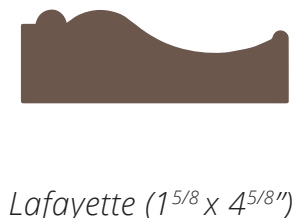
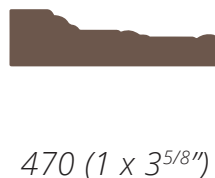
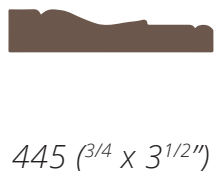
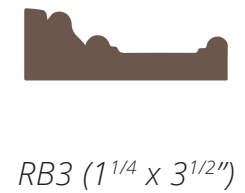
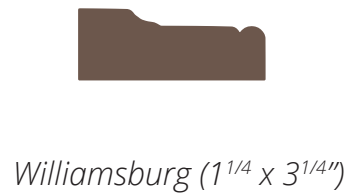
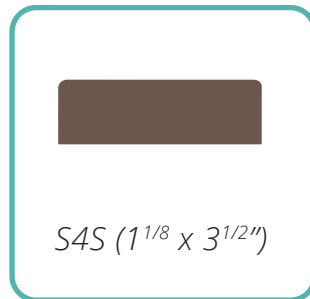
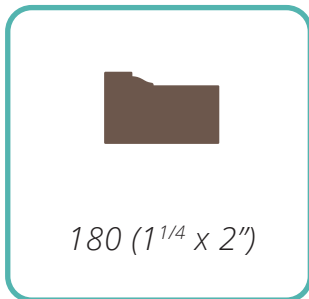

Artisan Pre-finish Options

Have your door stained by DSA's Master Artisans. We finish each door with care, applying a custom stain and protective clear coat to maximize the beauty of natural wood grain.

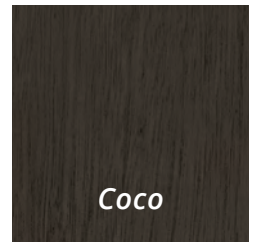
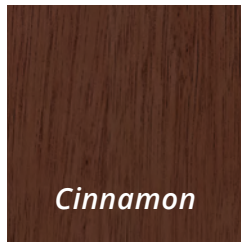

Hardware Options

DSA offers handlesets compatible with our Port Collection's Ashland Multipoint Active & Passive Locking System. Handlesets are available in your choice of Satin Nickel or Black finish. *Double door Port Collection configurations will require both Active and Passive handlesets.*

EMTEK® Lever Handlesets (Configuration #4)



#1 Arched



#2 Square



#3 Contemporary

- HVHZ Impact Rated
 - WBD Impact Rated
- Ashland Multipoint Locking System included with door*

Upgraded Hardware Options *(Single HVHZ Doors only)*

DSA offers a GU® Secury™ 3-Point Locking System for Single HVHZ doors only, which features automatic top & bottom latchbolts with tempered steel latches that automatically engage when door is closed, and is compatible with additional handleset and smart lock options.



GU® Secury™ 3-Point Lock with Berkeley Thumbblatch

Choose from Standard (left) or Danalock V3 Smart Lock (right)

Available in Black or Satin Nickel finish

Smart Lock includes GU Multipoint Lock, Active handle, Danalock V3, and Danabridge V3

- HVHZ Impact Rated (E-01 or E-01B doors only)

GU® Secury™ 3-Point Lock with Belconto Lever & Smart Lock

- HVHZ Impact Rated (E-01 or E-01B doors only)

Smart Lock includes GU Multipoint Lock, Active handle, Danalock V3, and Danabridge V3

Available in Black or Satin Nickel finish



Interior Danalock V3

Optional Danapad V3

Danapad V3 exterior mounted keypad also available in choice of Black or Satin Nickel



CUSTOM IMPACT DOOR OPTIONS

At DSA Doors, we produce an impressive selection of fully custom doors, and the following selections can be made on our Port Collection doors. Extra charges and extended lead time applies. Contact your DSA Dealer for further information.

Premium Impact Glass Styles

Custom glass styles are available to compliment your home, providing a personalized flair. Shadow bars can also be inserted in the glass to give the appearance of classic divided lites.



Custom Impact Doors

DSA's Custom Designers can provide a wide range of Impact options to fit any coastal home. From custom sizes and lite designs, to custom timber and decorative elements, DSA can bring your inspiration to life. Work with your DSA Dealer to begin the process of designing your custom impact door.



BISCAYNE SERIES



BISCAYNE SINGLE DOORS

● HVHZ Impact
Rated

● WBD Impact
Rated

HVHZ Door Sizes:
3'0" x 6'8", 8'0"

WBD Door Sizes:
2'8", 3'0" x 6'8", 8'0"

Configuration:
E-01

Timber:
2 1/4" Stain Grade
Mahogany

Glass:
Clear Laminated
Impact IG Low E

Jamb Size:
4 9/16" &
6 9/16"

* 8LT available in
8'0" height only



1LT



2LT



3LT



4LT

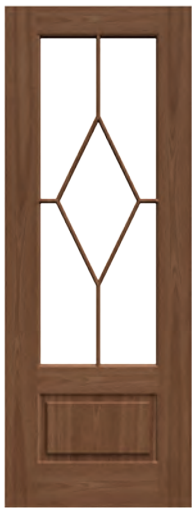

5LT



6LT



7LT



8LT*

BISCAYNE DOUBLE DOORS

● HVHZ Impact
Rated

● WBD Impact
Rated

HVHZ Door Sizes:
6'0" x 6'8", 8'0"

WBD Door Sizes:
5'4", 6'0" x 6'8", 8'0"

Configuration:
E-04

Timber:
2 1/4" Stain Grade
Mahogany

Glass:
Clear Laminated
Impact IG Low E

Jamb Size:
4 9/16" & 6 9/16"

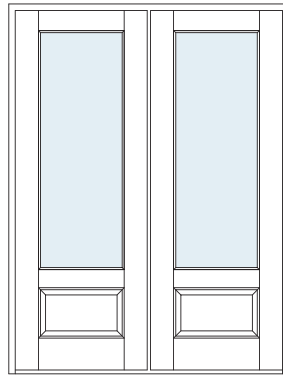

1LT

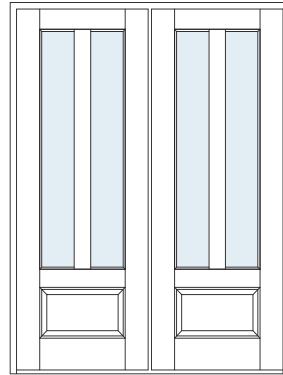

2LT



3LT



4LT

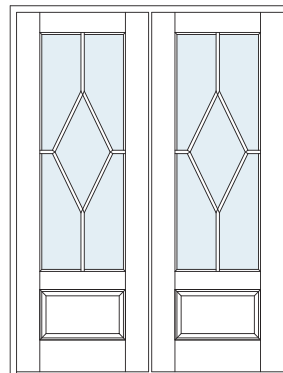

5LT



6LT



7LT

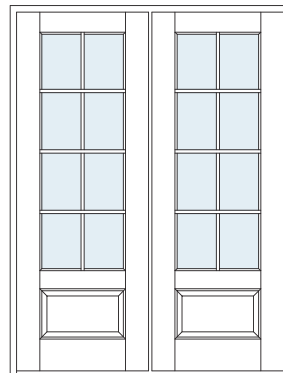

8LT*

* 8LT available in
8'0" height only



E-01 + SL



E-03

BISCAYNE SINGLE DOOR SIDE LITES

● WBD Impact Rated

WBD Door Sizes:
2'8", 3'0" x 6'8", 8'0"

Configurations:
E-01+1SL, E-03

Matching Side Lites:
3LT, 4LT, 5LT, 6LT & 8LT door styles

1 Lite Side Lites:
All Biscayne door styles

Side Lite Sizes:
12" or 14"

Timber:
2 1/4" Stain Grade Mahogany

Glass:
Clear Laminated Impact IG Low E

Jamb Size:
4 9/16" & 6 9/16"

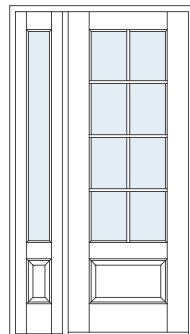
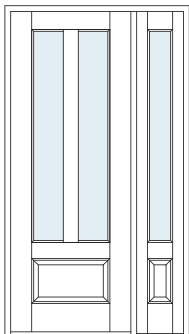
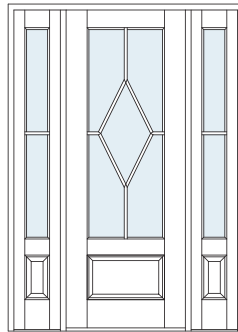
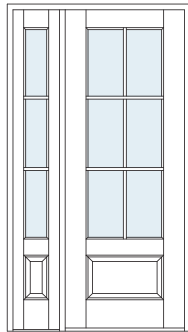

BISCAYNE SINGLE DOOR SIDE LITES & TRANSOMS

WBD Door Sizes: 3'0" x 6'8", 8'0"

Configuration: E-09

Side Lite & Transom Sizes: 12" or 14"

● WBD Impact Rated

Timber: 2 1/4" Stain Grade Mahogany

Glass: Clear Laminated Impact IG
Low E

Jamb Size: 4 9/16" & 6 9/16"

E-09 Transom Styles:

1LT

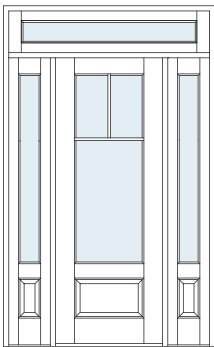

for all styles

2LT

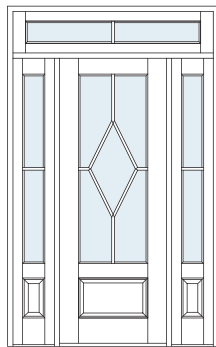

for 4LT & 5LT doors

3LT Even



for 3LT & 6LT doors

4LT Transom



for 3LT, 4LT, 5LT, 6LT & 8LT door styles

3LT Marginal

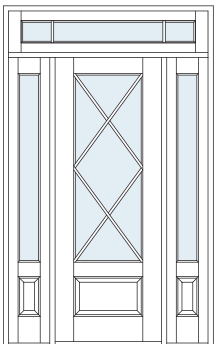

for all styles

3LT Wide

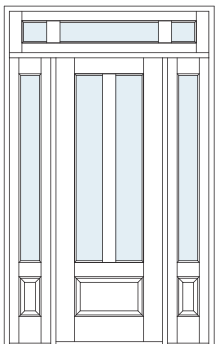

for 2LT door

5LT

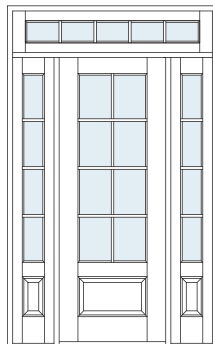

for 3LT, 4LT, 6LT & 8LT door styles

BISCAYNE

DOUBLE DOOR TRANSOMS

WBD Door Sizes: 6'0" x 6'8", 8'0"

Configuration: E-04+T

Transom Sizes: 12" or 14"

E-04+T Transom Styles:

3LT Wide Transom



for 2LT doors

● WBD Impact Rated

Timber: 2 1/4" Stain Grade Mahogany

Glass: Clear Laminated Impact IG Low E

Jamb Size: 4 9/16" & 6 9/16"

1LT

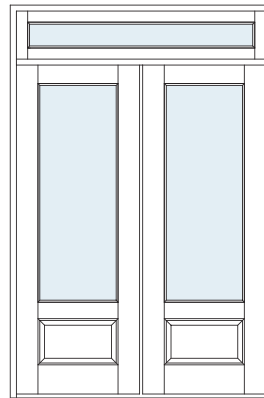

for all door styles

3LT



*for 3LT, 4LT, 5LT, 6LT
& 8LT door styles*

4LT



*for 3LT, 4LT, 5LT, 6LT
& 8LT door styles*

5LT

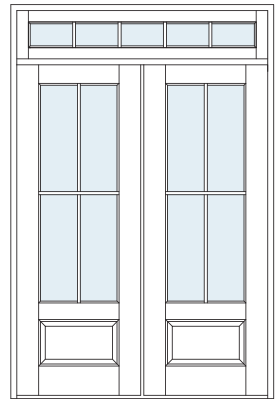

*for 3LT, 4LT, 5LT, 6LT
& 8LT door styles*

CLEARWATER SERIES



CLEARWATER ARCHED DOORS

● WBD Impact Rated

WBD Door Sizes:
3'0", 5'4", 6'0" x 8'0"

Configurations:
E-01B, E-17

Timber:
2 1/4" Stain Grade
Mahogany

Glass:
Clear Laminated
Impact IG Low E

Jamb Size:
4 9/16" & 6 9/16"



1LT



3LT



Prairie Lite



4LT



6LT



8LT



CLEARWATER ARCHED DOORS

● WBD Impact Rated

WBD Door Sizes:
3'0", 5'4", 6'0" x 8'0"

Configurations:
E-01B, E-17

Timber:
2 1/4" Stain Grade
Mahogany

Glass:
Clear Laminated
Impact IG Low E

Jamb Size:
4 9/16" & 6 9/16"



10LT



Border Lite



Diamond Lite



Halo Lite



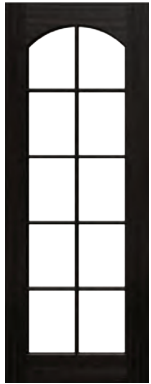

10LT



Border Lite

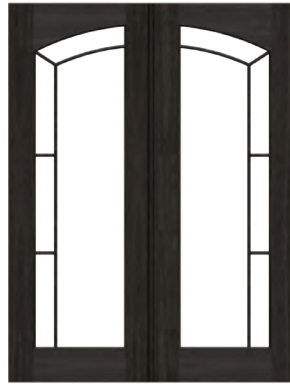

Halo Lite



Diamond Lite



CLEARWATER SQUARE DOORS

● WBD Impact Rated

WBD Door Sizes:
3'0", 5'4", 6'0" x 8'0"

Configurations:
E-01, E-04

Timber:
2 1/4" Stain Grade
Mahogany

Glass:
Clear Laminated
Impact IG Low E

Jamb Size:
4 9/16" & 6 9/16"



CLEARWATER SQUARE DOORS

● WBD Impact Rated

WBD Door Sizes:
3'0", 5'4", 6'0" x 8'0"

Configurations:
E-01, E-04

Timber:
2 1/4" Stain Grade
Mahogany

Glass:
Clear Laminated
Impact IG Low E

Jamb Size:
4 9/16" & 6 9/16"



1LT



3LT



Prairie Lite



4LT



6LT



8LT



CLEARWATER DOUBLE DOOR TRANSOMS

WBD Door Sizes: 6'0" x 8'0"

Configuration: E-04+T

Transom Sizes: 12" or 14"

E-04 + T Transom Styles:

3LT



* SDL placement for 3LT transom differs based on door style

● WBD Impact Rated

Timber: 2 1/4" Stain Grade Mahogany

Glass: Clear Laminated Impact IG Low E

Jamb Size: 4 9/16" & 6 9/16"

1LT

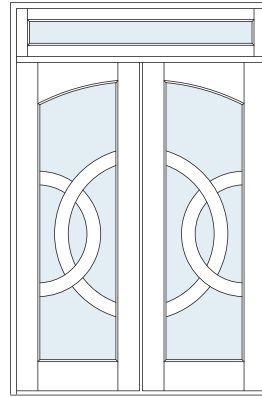

for all door styles

3LT

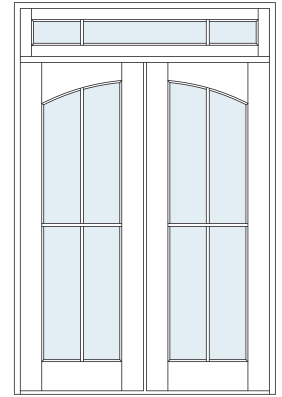

*for 4LT, 6LT, 8LT, 10LT,
Border & Prairie doors*

4LT

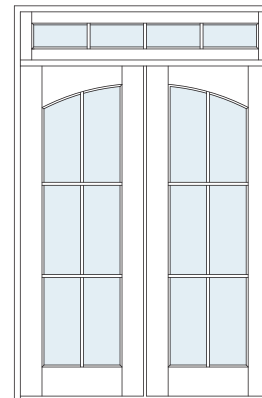

*for 4LT, 6LT, 8LT
& 10LT door styles*

5LT

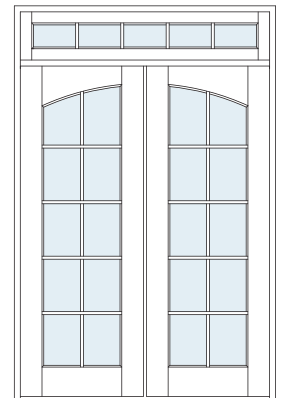

*for 4LT, 6LT, 8LT
& 10LT door styles*

LUCIE SERIES





1LT

2LT



4LT

6LT



8LT

Border Lite

LUCIE ARCHED DOORS

- HVHZ Impact Rated
- WBD Impact Rated

HVHZ Door Sizes:
3'0", 6'0" x 8'0"

WBD Door Sizes:
3'0", 5'4", 6'0" x 8'0"

Configurations:
E-01B, E-17

Timber:
2 1/4" Stain Grade
Mahogany

Glass:
Clear Laminated
Impact IG Low E

Jamb Size:
4 9/16" & 6 9/16"



7LT



Solid Panel



3LT

LUCIE ARCHED DOORS

- HVHZ Impact Rated
- WBD Impact Rated

HVHZ Door Sizes:
3'0", 6'0" x 8'0"

WBD Door Sizes:
3'0", 5'4", 6'0" x 8'0"

Configurations:
E-01B, E-17

Timber:
2 1/4" Stain Grade
Mahogany

Glass:
Clear Laminated
Impact IG Low E

Jamb Size:
4 9/16" & 6 9/16"





LUCIE SQUARE DOORS

● HVHZ Impact Rated

● WBD Impact Rated

HVHZ Door Sizes:
3'0", 6'0" x 8'0"

WBD Door Sizes:
3'0", 5'4", 6'0" x 8'0"

Configurations:
E-01B, E-17

Timber:
2 1/4" Stain Grade
Mahogany

Glass:
Clear Laminated
Impact IG Low E

Jamb Size:
4 9/16" & 6 9/16"

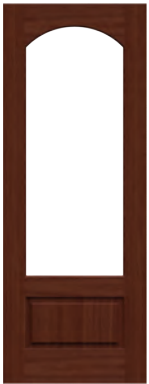

1LT



2LT



4LT



6LT



8LT



Border Lite



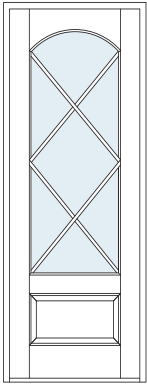

7LT

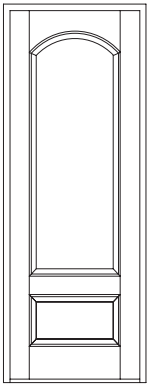
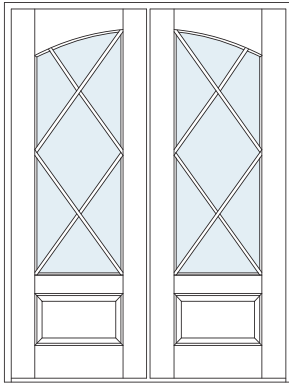

Solid Panel

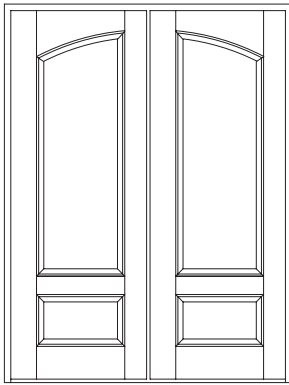

3LT

LUCIE SQUARE DOORS

- HVHZ Impact Rated
- WBD Impact Rated

HVHZ Door Sizes:
3'0", 6'0" x 8'0"

WBD Door Sizes:
3'0", 5'4", 6'0" x 8'0"

Configurations:
E-01B, E-17

Timber:
2 1/4" Stain Grade
Mahogany

Glass:
Clear Laminated
Impact IG Low E

Jamb Size:
4 9/16" & 6 9/16"

LUCIE

DOUBLE DOOR TRANSOMS

WBD Door Sizes: 6'0" x 8'0"

Configuration: E-04+T

Transom Sizes: 12" or 14"

● WBD Impact Rated

Timber: 2 1/4" Stain Grade Mahogany

Glass: Clear Laminated Impact IG Low E

Jamb Size: 4 9/16" & 6 9/16"

E-04+T Transom Styles:

1LT



for all door styles

3LT



for 3LT, 4LT, 6LT & 8LT door styles

3LT



for Border Lite door

4LT



for 3LT, 4LT, 6LT, 8LT & Solid Panel door styles

5LT



for 3LT, 4LT, 6LT, 8LT & Solid Panel door styles

NAPLES SERIES







1LT



3LT



Vertical 3LT



5LT



6LT



7LT



8LT



9LT

NAPLES SINGLE DOORS

● HVHZ Impact
Rated

● WBD Impact
Rated

HVHZ Door Sizes:
3'0" x 6'8", 8'0"

WBD Door Sizes:
2'8", 3'0" x 6'8", 8'0"

Configuration:
E-01

Timber:
2 1/4" Stain Grade
Mahogany

Glass:
Clear Laminated
Impact IG Low E

Jamb Size:
4 9/16" & 6 9/16"

NAPLES DOUBLE DOORS

● HVHZ Impact
Rated

● WBD Impact
Rated

HVHZ Door Sizes:
6'0" x 6'8", 8'0"

WBD Door Sizes:
5'4", 6'0" x 6'8", 8'0"

Configuration:
E-04

Timber:
2 1/4" Stain Grade
Mahogany

Glass:
Clear Laminated
Impact IG Low E

Jamb Size:
4 9/16" & 6 9/16"

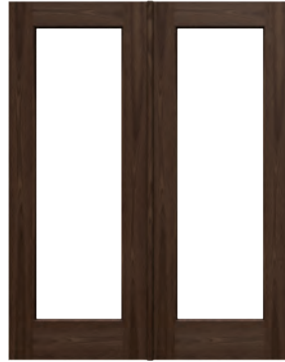

1LT



3LT



Vertical 3LT



4LT*



5LT



6LT



7LT



8LT



9LT

* 4LT available in
8'0" height only



E-01 + SL



E-03

NAPLES SINGLE DOOR SIDE LITES

● WBD Impact Rated

WBD Door Sizes:
2'8", 3'0" x 6'8", 8'0"

Configurations:
E-01+1SL, E-03

Matching Side Lites:
3LT, 5LT, 6LT, 8LT, & 9LT door styles

1 Lite Side Lites:
All Naples door styles

Side Lite Sizes:
12" or 14"

Timber:
2 1/4" Stain Grade Mahogany

Glass:
Clear Laminated Impact IG Low E

Jamb Size:
4 9/16" & 6 9/16"

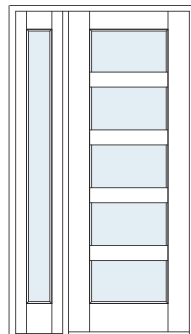
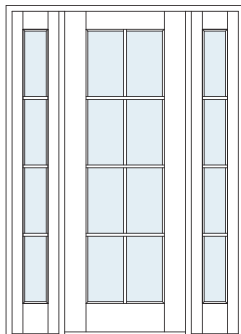
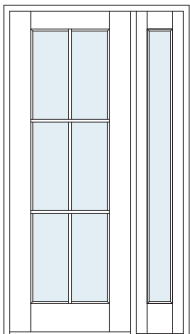
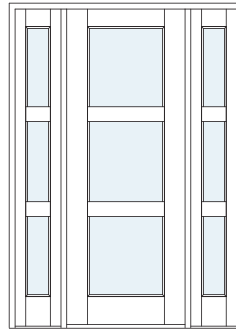
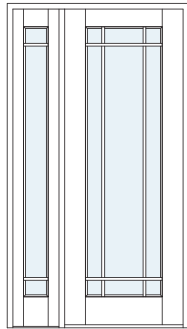
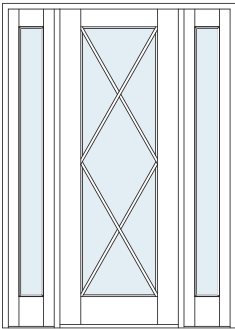

NAPLES SINGLE DOOR SIDE LITES & TRANSOMS

WBD Door Sizes: 3'0" x 6'8", 8'0"

Configuration: E-09

Side Lite & Transom Sizes: 12" or 14"

● WBD Impact Rated

Timber: 2 1/4" Stain Grade Mahogany

Glass: Clear Laminated Impact IG
Low E

Jamb Size: 4 9/16" & 6 9/16"

E-09 Transom Styles:

1LT

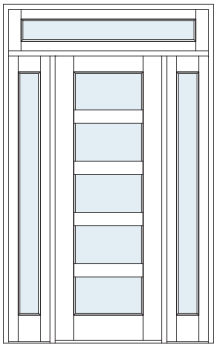

for all styles

3LT Even

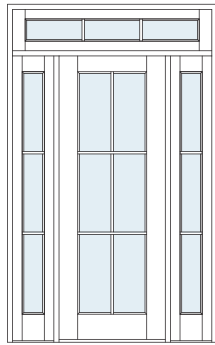

for 6LT door

3LT Marginal

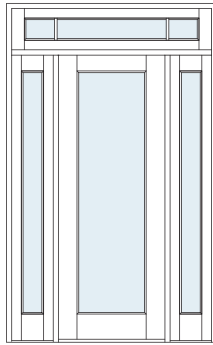

for all styles

3LT Wide Transom



for 3LT, 3LT Vertical & 5LT door styles

3LT Prairie

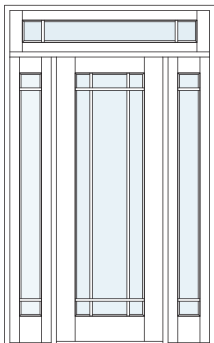

for 9LT door

4LT

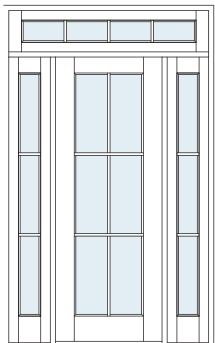

for 6LT & 8LT doors

5LT

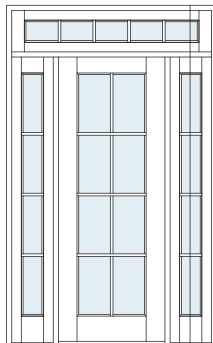

for 6LT & 8LT doors

NAPLES

DOUBLE DOOR TRANSOMS

WBD Door Sizes: 6'0" x 6'8", 8'0"

Configuration: E-04+T

Transom Sizes: 12" or 14"

E-04+T Transom Styles:

3LT



* SDL placement for 3LT E04+T transom differs based on the door style

● WBD Impact Rated

Timber: 2 1/4" Stain Grade Mahogany

Glass: Clear Laminated Impact IG Low E

Jamb Size: 4 9/16" & 6 9/16"

1LT

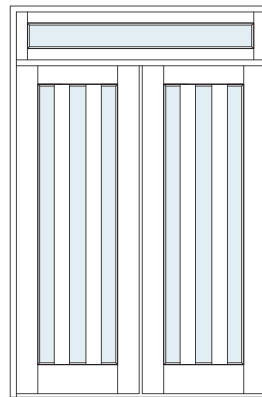

for all styles

3LT *

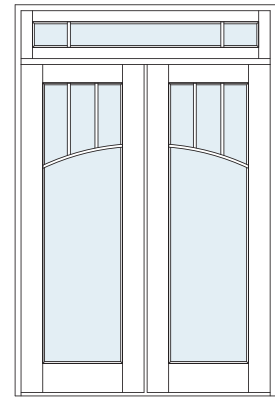

for 4LT, 6LT, 8LT & 9LT doors

4LT

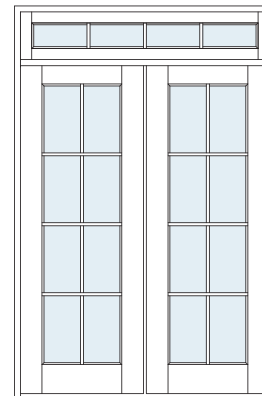

for 6LT & 8LT doors

5LT

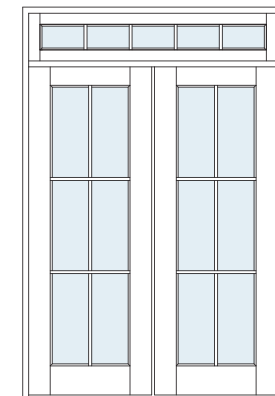

for 6LT & 8LT doors

VENICE SERIES



VENICE ARCHED DOORS

- HVHZ Impact Rated
- WBD Impact Rated

HVHZ Door Sizes:
3'0", 6'0" x 8'0"

WBD Door Sizes:
3'0", 5'4", 6'0" x 8'0"

Configurations:
E-01B, E-17

Timber:
2 1/4" Stain Grade
Mahogany

Glass:
Clear Laminated
Impact IG Low E

Jamb Size:
4 9/16" & 6 9/16"

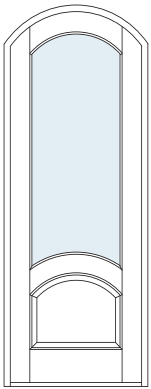

1LT

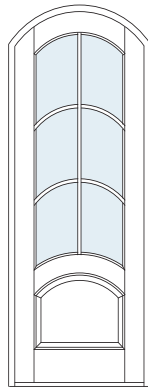
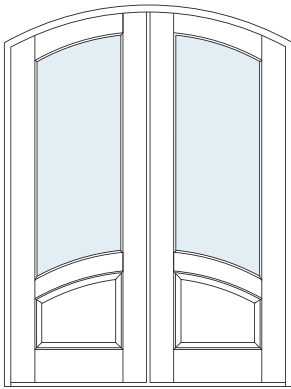

6LT

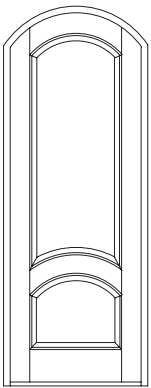

Solid Panel (*available grooved*)

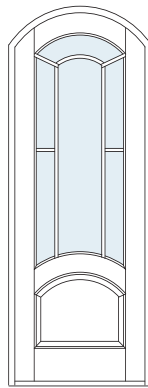
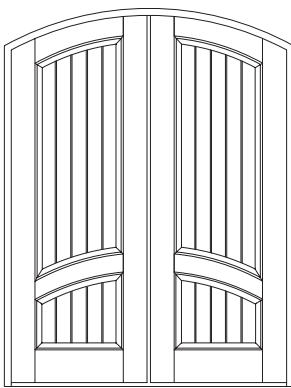

Border Lite



3LT



9LT



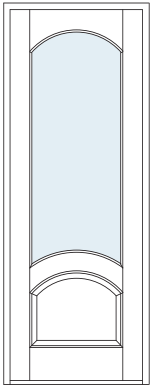

1LT

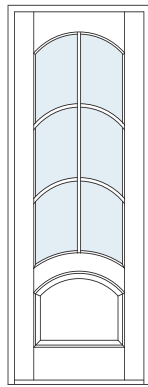
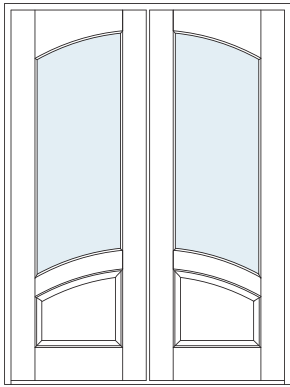

6LT

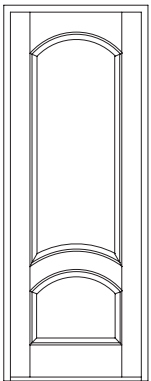

Solid Panel *(available smooth or grooved)*

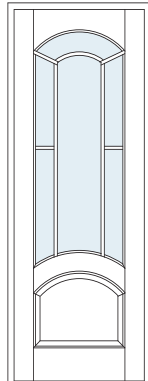
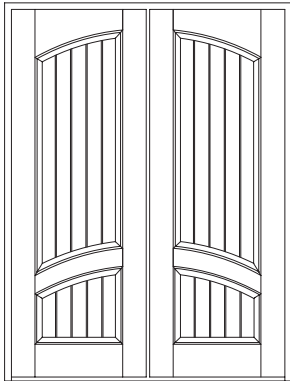

Border Lite



3LT



9LT

VENICE SQUARE DOORS

● HVHZ Impact Rated

● WBD Impact Rated

HVHZ Door Sizes:
3'0", 6'0" x 8'0"

WBD Door Sizes:
3'0", 5'4", 6'0" x 8'0"

Configurations:
E-01, E-04

Timber:
2 1/4" Stain Grade
Mahogany

Glass:
Clear Laminated
Impact IG Low E

Jamb Size:
4 9/16" & 6 9/16"





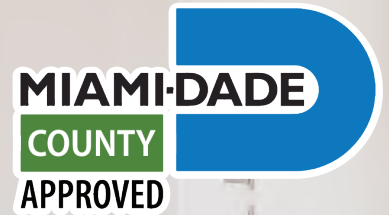

DSA Master Crafted Doors

10681 World Trade Blvd, Raleigh NC 27617 • (919) 781-3200

Visit us at www.DSADoors.com